

42□ 1.8°

17PM-K

1.8°

■ 外観図 Outline

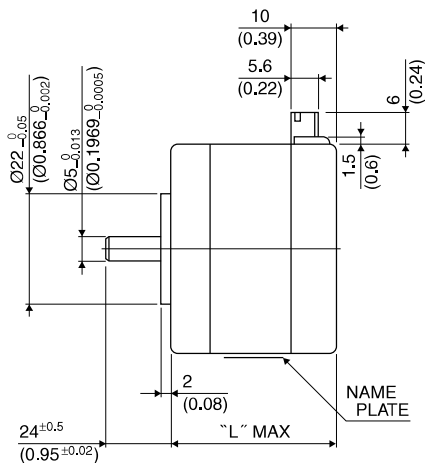
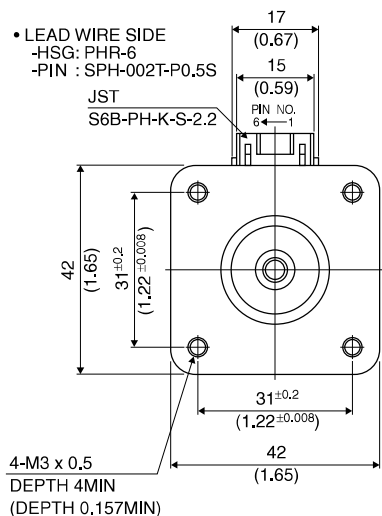

Hybrid

結線表 PIN NO. vs. PHASE

相 (PHASE)	A	A COM	\bar{A}	B	B COM	\bar{B}
ピン番号 (PIN NO.)	4	5	6	3	2	1

	"L"
17PM-K7**	26 (1.02)
17PM-K2**	30 (1.18)
17PM-K0**	34 (1.34)
17PM-K3**	38 (1.50)
17PM-K1**	42 (1.65)
17PM-K4**	48 (1.89)
17PM-KA**	60 (2.36)

■ 仕様 Specifications

型式	ステップ角	ドライブ方式	定格電流	巻線抵抗	ホールディングトルク	インダクタンス	ロータイナーシャ	ディテントトルク	質量
Model	Step Angle	Drive Sequence	Rated Current	Resistance	Holding Torque	Inductance	Rotor Inertia	Detent Torque	Mass
	(deg)		(A)	(Ohms)	(mNm)	(mH)	(g·cm ²)	(mNm)	(g)
17PM-K044U	1.8	UNI-POLAR	1.2	2.3	200	2.2	37	11.0	200
17PM-K049U	1.8	UNI-POLAR	1.0	3.2	200	3.2	37	11.0	200
17PM-K064U	1.8	UNI-POLAR	0.6	8.3	200	8.1	37	11.0	200
17PM-K142U	1.8	UNI-POLAR	1.4	2.3	280	3.2	62	11.8	300
17PM-K149U	1.8	UNI-POLAR	1.0	4.3	280	6.0	62	11.8	300
17PM-K249U	1.8	UNI-POLAR	0.8	2.7	100	3.0	24	4.3	180
17PM-K264U	1.8	UNI-POLAR	0.6	6.9	100	7.4	24	4.3	180
17PM-K342U	1.8	UNI-POLAR	1.4	2.0	250	2.5	50	11.3	250
17PM-K349U	1.8	UNI-POLAR	1.0	3.6	250	4.7	50	11.3	250
17PM-K442U	1.8	UNI-POLAR	1.4	2.8	400	3.4	75	16.7	350
17PM-K449U	1.8	UNI-POLAR	1.0	4.9	400	6.5	75	16.7	350
17PM-K749U	1.8	UNI-POLAR	0.9	2.2	50	1.6	11	2.8	150
17PM-K764U	1.8	UNI-POLAR	0.6	5.6	50	4.1	11	2.8	150
17PM-KA39U	1.8	UNI-POLAR	1.4	2.9	485	4.0	120	21.6	490
17PM-KA46U	1.8	UNI-POLAR	1.0	5.6	485	8.1	120	21.6	490

型式	ステップ角	ドライブ方式	定格電流	巻線抵抗	ホールディングトルク	インダクタンス	ロータイナーシャ	ディテントトルク	質量
Model	Step Angle	Drive Sequence	Rated Current	Resistance	Holding Torque	Inductance	Rotor Inertia	Detent Torque	Mass
	(deg)		(A)	(Ohms)	(mNm)	(mH)	(g·cm ²)	(mNm)	(g)
17PM-K053B	1.8	BI-POLAR	1.2	2.2	270	4.6	37	11.0	200
17PM-K058B	1.8	BI-POLAR	1.0	3.0	270	6.4	37	11.0	200
17PM-K046B	1.8	BI-POLAR	0.8	5.0	270	10.3	37	11.0	200
17PM-K049B	1.8	BI-POLAR	0.7	6.4	270	12.8	37	11.0	200
17PM-K051B	1.8	BI-POLAR	0.65	7.8	270	15.9	37	11.0	200
17PM-K149B	1.8	BI-POLAR	1.4	2.2	380	6.1	62	11.8	300
17PM-K142B	1.8	BI-POLAR	1.0	4.6	380	12.9	62	11.8	300
17PM-K249B	1.8	BI-POLAR	0.6	5.4	140	12.0	24	4.3	180
17PM-K348B	1.8	BI-POLAR	1.4	1.8	310	4.3	50	11.3	250
17PM-K353B	1.8	BI-POLAR	1.2	2.5	310	6.2	50	11.3	250
17PM-K342B	1.8	BI-POLAR	0.9	4.0	310	9.9	50	11.3	250
17PM-K349B	1.8	BI-POLAR	0.7	7.4	310	18.0	50	11.3	250
17PM-K448B	1.8	BI-POLAR	1.5	2.4	500	5.8	75	16.7	350
17PM-K442B	1.8	BI-POLAR	0.9	5.6	500	13.6	75	16.7	350
17PM-K749B	1.8	BI-POLAR	0.6	4.4	65	6.4	11	2.8	150
17PM-KA45B	1.8	BI-POLAR	1.5	2.7	610	7.5	120	21.6	490
17PM-KA39B	1.8	BI-POLAR	1.0	6.0	610	15.9	120	21.6	490

■ トルク・スピード特性 Torque/Speed Characteristics

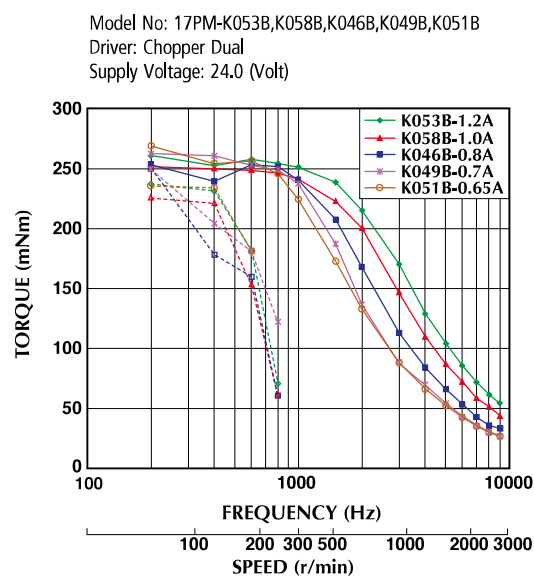
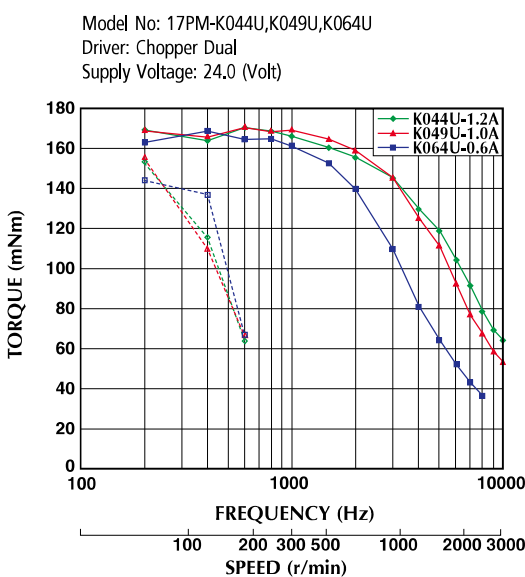

■ トルク特性は当社測定による参考データで、保証値ではありません。また、条件が変化すると、特性が変化する場合があります。
■ Torque/Speed characteristics are for reference only and it may change when operated at different drive conditions.

■ このカタログに掲載している製品の性能及び仕様は、改良の為予告なく変更することがありますのでご了承ください。
■ Specifications are subject to change without notice.

— : PULL OUT
- - - : PULL IN

■ トルク・スピード特性 Torque/Speed Characteristics

Model No: 17PM-K142U,K149U
Driver: Chopper Dual
Supply Voltage: 24.0 (Volt)

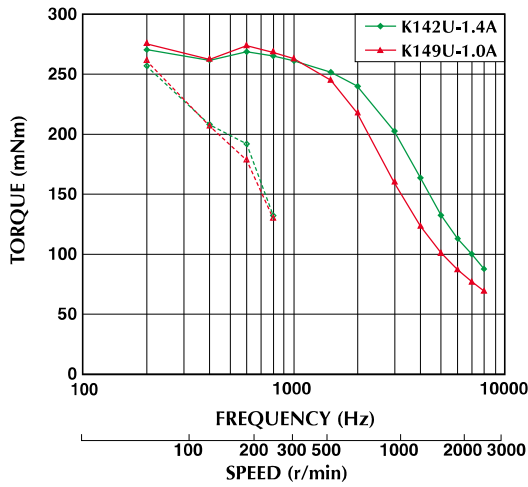

Model No: 17PM-K149B,K142B
Driver: Chopper Dual
Supply Voltage: 24.0 (Volt)

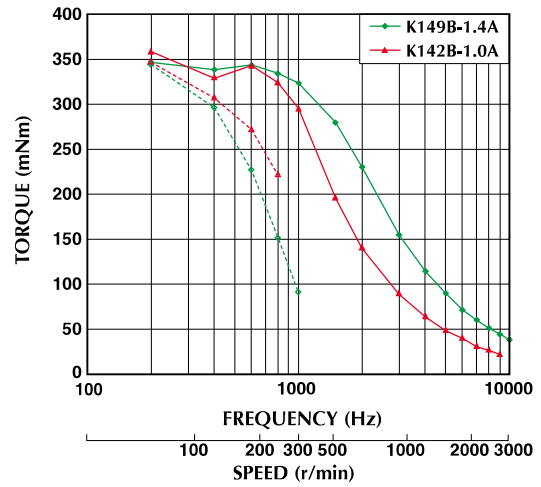

Model No: 17PM-K249U,K264U
Driver: Chopper Dual
Supply Voltage: 24.0 (Volt)

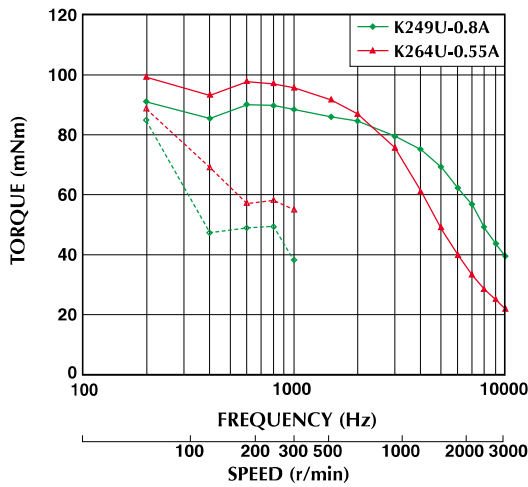

Model No: 17PM-K249B
Driver: Chopper Dual
Supply Voltage: 24.0 (Volt)

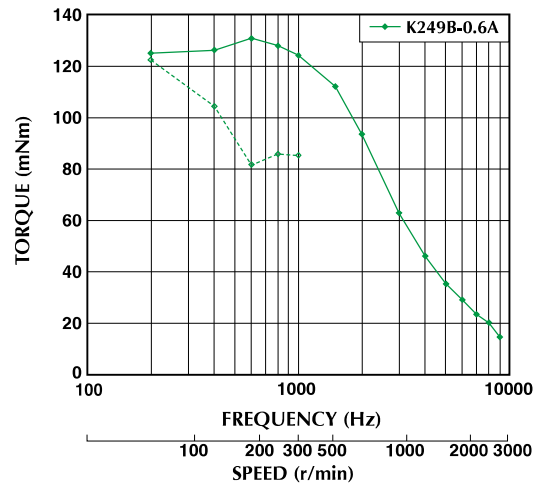

Model No: 17PM-K342U,K349U
Driver: Chopper Dual
Supply Voltage: 24.0 (Volt)

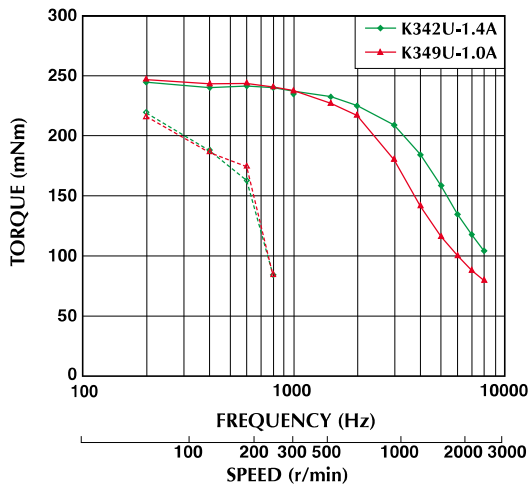

Model No: 17PM-K348B,K353B,K342B,K349B
Driver: Chopper Dual
Supply Voltage: 24.0 (Volt)

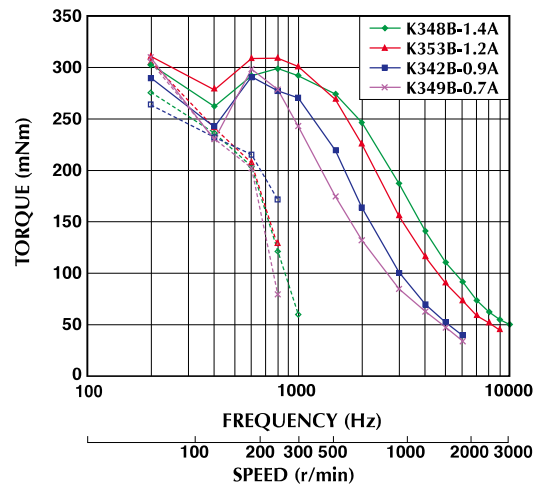

■ トルク特性は当社測定による参考データで、保証値ではありません。また、条件が変化すると、特性が変化する場合があります。
■ Torque/Speed characteristics are for reference only and it may change when operated at different drive conditions.

■ このカタログに掲載している製品の性能及び仕様は、改良の為予告なく変更することがありますのでご了承ください。
■ Specifications are subject to change without notice.

— : PULL OUT
- - - : PULL IN

■ トルク・スピード特性 Torque/Speed Characteristics

Model No: 17PM-K442U,K449U
Driver: Chopper Dual
Supply Voltage: 24.0 (Volt)

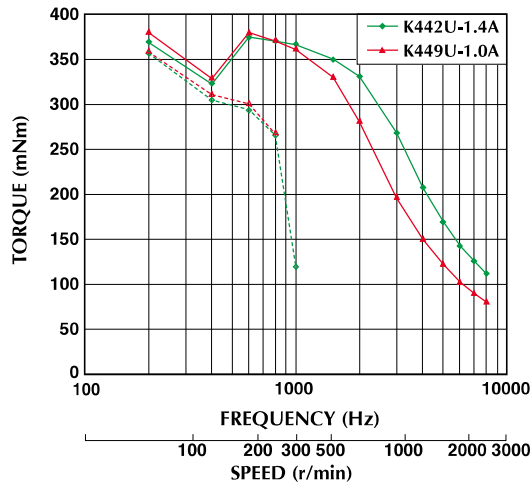

Model No: 17PM-K448B,K442B
Driver: Chopper Dual
Supply Voltage: 24.0 (Volt)

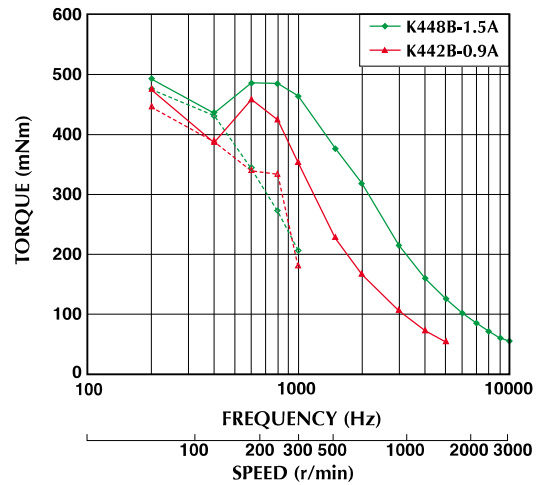

Model No: 17PM-K749U,K764U
Driver: Chopper Dual
Supply Voltage: 24.0 (Volt)

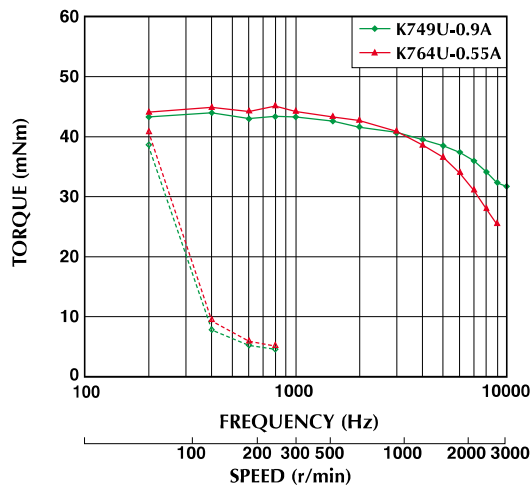

Model No: 17PM-K749B
Driver: Chopper Dual
Supply Voltage: 24.0 (Volt)

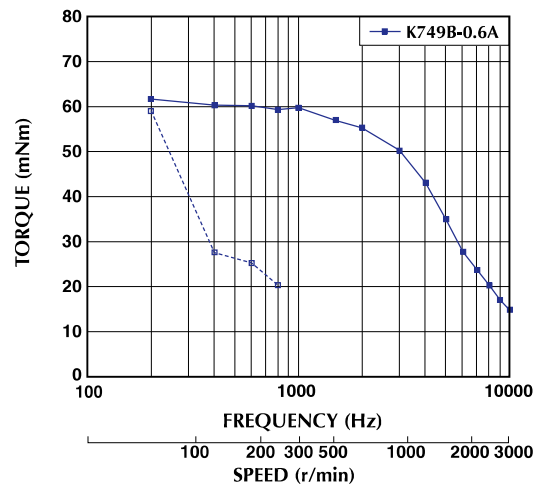

Model No: 17PM-KA39U, KA46U
Driver: Chopper Dual
Supply Voltage: 24.0 (Volt)

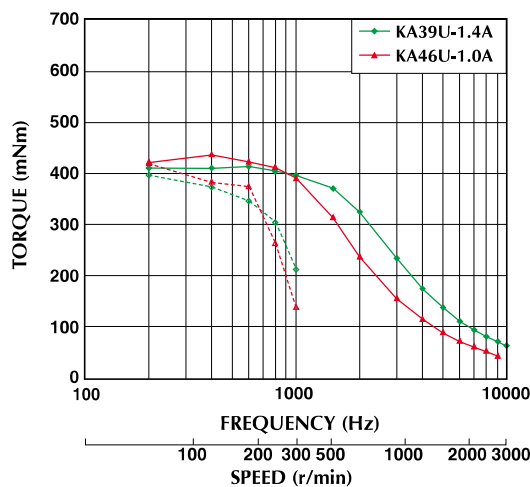

Model No: 17PM-KA45B, KA39B
Driver: Chopper Dual
Supply Voltage: 24.0 (Volt)

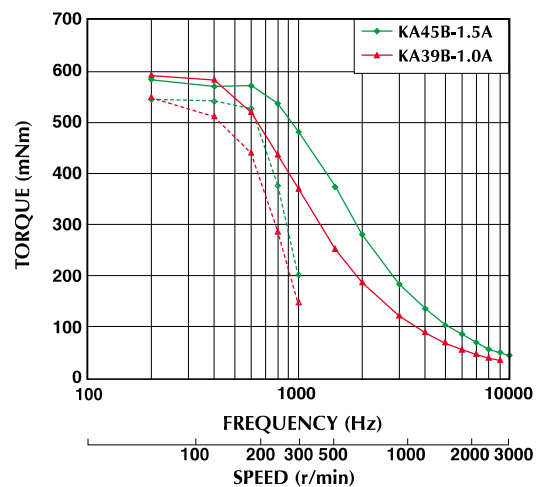

■ トルク特性は当社測定による参考データで、保証値ではありません。また、条件が変化すると、特性が変化する場合があります。
■ Torque/Speed characteristics are for reference only and it may change when operated at different drive conditions.

■ このカタログに掲載している製品の性能及び仕様は、改良の為予告なく変更することがありますのでご了承ください。
■ Specifications are subject to change without notice.

— : PULL OUT
- - - : PULL IN